



Rimedyne

齐力制冷系统（深圳）有限公司

半导体空调

Thermal Electric



操作和安装手册

Operation and Installment Manual

***** IMPORTANT *****

提示：请仔细阅读此手册，按照本系统操作说明安装和使用该系统。请保留此手册，以便将来参考。某些内容可能并不适用于全部系统。

Tips: Please read this manual carefully, install and use this system based on this system operation instruction. Keep this manual for further reference. Some contents may not be suitable for this system.

目录

Catalogue

1. 介绍	Introduction	3
3. 开箱检查	The Open-package Inspection	4
4. 安装前检测	Pre-Installment Test	4
5. 空调的安装	Prepare the Enclosure	5
6. 功能介绍	Functionality Introduction	7
6.1	电源供电 Power Supply	7
6.2	风机转速和加热, 制冷功能, 机柜内部温度曲线 Fan Speed, Heating and Cooling functions, Cabinet inside temperature Curve	7
6.3	指示灯 Lighting	10
6.4	故障分析 Fault Analysis	11
6.5	电压保护 Voltage protect	12
6.6	误报警过滤功能 False alarm filtering function	13
6.7	后台监控协议 Monitor protocol	14
6.8	控制板接口 Control board interface	14
7. 界面说明	Interface Introduction	15
7.1	PC 监控软件操作 PC Monitoring software operation	19
7.2	电路板线路图 Electrical Interface-Circuit diagram	19
7.3	电源 Power Input	20
7.4	安装注意事项 Installment cautions	20
8. 保修	Warranty	20
8.1	免责范围 Disclaimer Range	21
9. 制造商地址	Manufacturer Address	21

1. 介绍 Introduction

齐力的半导体空调是一款可以对现代化电子设备箱的内部环境实现冷却散热、加热等功能控制的新一代产品。我们的产品高效节能，外形美观，最高COP可达1.0。科学严谨的封闭循环系统设计可有效的防止空气中的灰尘和污染物对您设备造成损坏。空调的制冷量选择根据您的需求可从100W到500W——是一个广泛的制冷选择范围，可以满足您对空调的多种需要。

Rimedyne Thermal Electric is a new product which fulfills to control cooling and heating inner ambient of modern electrical enclosure. Our products are of high efficiency, energy saving and aesthetic appearance, COP reaching 1.0. Scientific precise closed circulative system design makes it possible to protect your equipments from dust and pollutants. The cooling capacity can range from 100W to 500W as your requirement, is a wide cooling selecting range, can meet with your various needs of TEC.

2. 工作原理及设备描述 Operation Principles and Equipment Description

TEC空调由半导体制冷片、隔热棉、冷端散热器、冷端风机、热端散热器、热端风机和控制系统七部分组成。当给TEC空调供电时，半导体制冷片一侧制冷，另一侧制热，所产生的冷（热）量分别通过冷（热）端散热风机扩散到周围环境。其中，冷端散热器和冷端风机组成的内循环，用于给机柜内部环境制冷；热端散热器和热端散热风机组成外循环，用于向外环境散热。如下图所示：

TEC air cooler include TE module, thermal insulation, cold radiator, cold side fan, heat radiator, heat side fan and Controller system seven parts. When TEC unit be charged by DC supply, the TEC chip one side is cooling and another side is heating. Energy of the cooling (heating) will spread to the surrounding environment through the cold (heat) side fan respectively. Internal circulation which is made up of cold radiator and cold side fan is used to supply cooling cabinet inner temperature. External circulation which is made up of heat radiator and heat side fan is used to spread heat to ambient. Please refer to the following drawing:

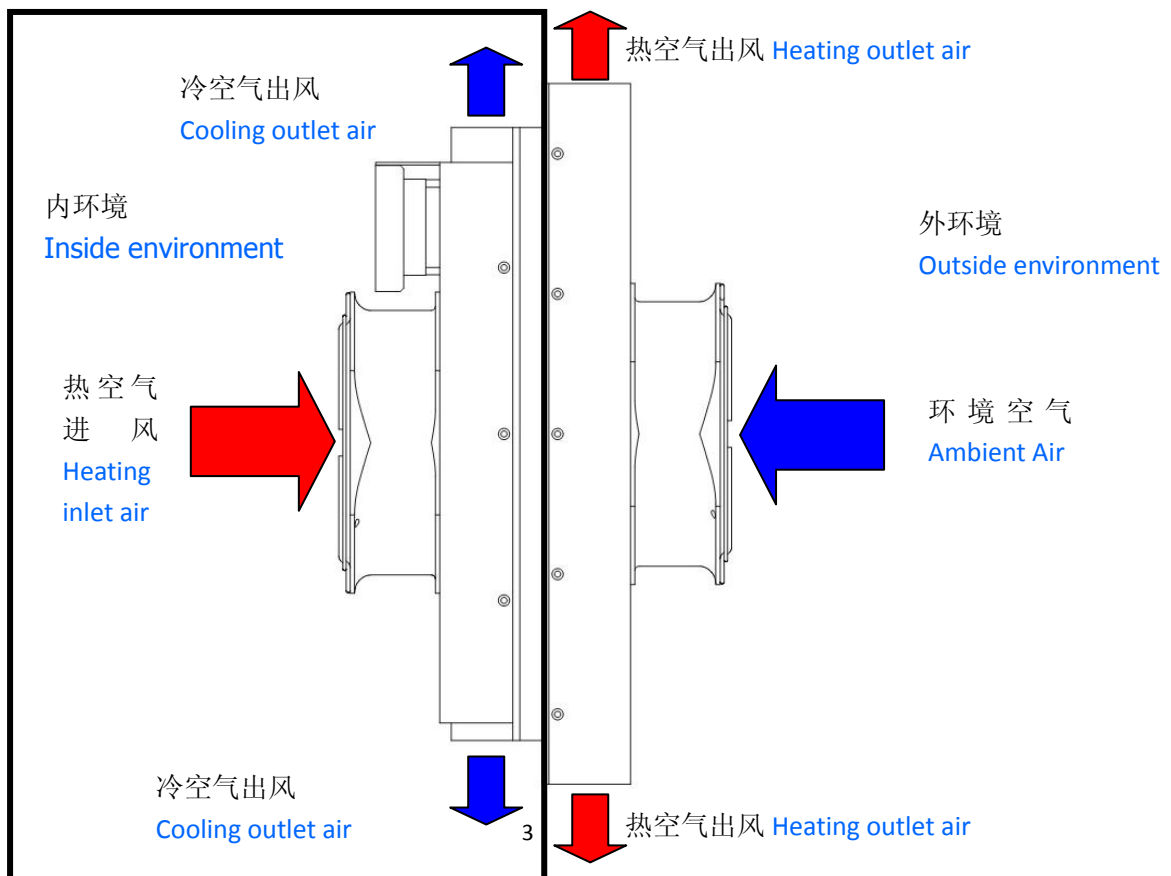

3. 开箱检查 **The Open-package Inspection**

空调拆包前请检查空调的包装箱是否完好。如果发现包装箱已有任何形式的损坏或是毁坏，请仔细地检查查看空调是否已被损坏。如：检查有无刮痕，凹痕，摇动是否有声响(可能空调内部有零件松动)。任何损坏的证据都需要记录在货运单上并报告承运人。该货运公司将提交关于赔偿的说明。齐力公司不承担在运送过程中空调发生损坏的赔偿。

Check any damage of the shipping container before unpacking TEC. If the shipping container has been damaged or marred in any way, carefully check to see if the Rimedyne TMC incurred any damage. Check any scratches, dents, rattles (which may indicate loose components), the presence of oil, and any other irregularities. Any evidence of damage will need to be recorded on the freight bill and reported to the carrier. The freight carrier will provide instructions on filing a claim. Rimedyne will not be of responsibility for damages that occur during shipping.

4. 安装前检测 **Pre-Installment Test**

在空调正式安装到设备之前，建议让空调运行20到30分钟以确保其正常运转。即使空调已在生产出货前进行过全面的检查和测试，但可能在运输或搬运过程中发生的内部损坏，在开箱检查时没有显现出来。

Before installing the Rimedyne system on the enclosure, it is recommended the unit operate for 20 to 30 minutes to ensure it is functioning properly. Although the Rimedyne TMS has been tested at the factory, internal damage may have occurred during shipping which may have not been apparent during the unpacking inspection.

a) 把空调放在一个坚固的平台上，确保空气流动有足够的空间，蒸发器和冷凝器进出风气流不能被阻挡。空调安装面确保平坦。

Place the system on a solid base such as a workbench or table. Be sure to allow adequate space for airflow. There are two air streams that must not be restricted, the cool air stream and the warm air stream. Units can only be mounted on a flat vertical surface.

b) 检查空调铭牌上对电源的要求。铭牌有标明空调系统的设计电压和所需的电流。请确保连接空调的插座能够满足空调的要求。注意以上内容后，把电源线正确的接地。

Check the data tag for proper electrical requirements. The data tag lists the design voltage and amperage requirements of the system. Verify that the electrical outlet where the system will be connected has the proper capacity. After noting the above, connect the power cord to a properly grounded electrical connection. The use of an extension cord is not recommended.

注意：在测试过程中如果有不正常的噪音或是震动出现，请立刻拔掉电源线并检查导致噪音或震动的位置，并立即联系齐力公司。

NOTE: If any unusual noise or vibration is present during the testing procedure, immediately disconnect the power cord and inspect the unit for the cause of the noise or vibration. Contact Rimedyne immediately.

d) 空调一旦通电，冷端风机就开始运作。当设备内空气温度低于30℃时，TEC芯片和热端风机将不会启动。这主要是控制器的出厂设置：温度高于30℃开始制冷。

如果测试的环境温度低于30℃，可以调整上位机软件设定值上的温度低于室内的温度，让TEC芯片和热端风机工作。请参阅手册中“控制器功能设置”的这一部分内容，以改变出厂设定值。

As soon as power is supplied to the system, the cool side fan will begin to operate. The TEC module and heat side fan will not operate if inner temperature is below 30℃. This is due to the factory setting of programmable controller: begin to cool when temperature is higher than 30℃.

If the testing temperature is less than 30℃, adjust the temperature set point lower than the room temperature in order to make TEC module and heat side fan to operate. Refer to the “Programming the Controller” section of this manual in order to change the factory set points.

e) 启动TEC空调，让空调运行10到15分钟，为系统实现平衡提供足够的时间。用电流表测量整机的电流是否与铭牌上标记接近。

To make sure offer enough time for system achieving balance, please let TEC running at 10 to 15 minutes after starting it. Check the unit electric current approach that of nameplate by using electric current measure.

f) 在完成以上检查要点之后，就可以为安装空调作准备了。

After completing the above check points, the electrical enclosure is ready to be prepared for the installation of TEC.

5. 空调的安装 Prepare the Enclosure

齐力空调系统设计的轻巧易安装。安装时可直接把空调镶入设备箱的开口，然后安装螺丝，使空调的安装更加快捷，方便。在保证安装安全可靠的前提下，对电子设备箱的开孔必须保证散热器进出风口有足够的空气流通，具体的开口随每个机型而定。

Rimedyne air conditioning systems have been designed to be light weight for ease of installation. Side enclosure or vertical mount units have been designed with a simple “two stud” alignment feature to make initial fastening to the enclosure quick and easy. A few modifications must be made to the enclosure to provide proper airflow, to maintain enclosure integrity and to assure a secure installation. Required modifications will vary with each air conditioner model.

a) 确定空调在设备机箱上的安装位置。

Determine the Installment location of TEC on the enclosure.

***** 注意*** CAUTION *****

请确认空调的安装不会导致设备箱的不平衡。设备箱重心不稳可能会造成身体受伤或设备的损坏。如果是将空调安装在设备门上，请确定它们能够承受空调的重量。具体机型重量请参阅空调规格书。

Verify the weight of the air conditioning system will not cause the enclosure unbalance. Equipment instability may cause bodily harm or equipment damage. For units mounted on enclosure doors, confirm the hinges will support the weight of TEC. Refer to TEC specifications for model weights.

b) 在安装空调前请参照空调安装背板图在设备箱上开口（安装背板图见附件），为空调的安装做准备。安装背板图上会标明空调的安装孔、散热器进出风口及连接线（电源线、控制线、数据线等）出口的位置及大小尺寸。请确保空调的安装位置，使散热器进出风口不会被设备箱内部框架所阻挡，并且空调周围空气的流

通不会受周围环境的影响。

Before installing TEC, please refer to TEC template installing drawing (TEC template installing drawing as attachment) and decide the openings on the enclosure. This template drawing will indicate the location and dimension of the mounting holes, radiator air inlet and outlet, and connecting line (power supply line, control line, data line). Be sure that TEC will be mounted level and the cool air inlet and outlet connections will not be restricted by equipment or shelving within the enclosure. Also check that the air flow of the warm air stream will not be effected or restricted by the surroundings.

c) 检查所有的开口和安装孔位准确无误后，将密封条按空调背面图所示紧贴在空调上，以确保空调与机柜之间安装后密封无漏气。

After checking that all openings and mounting holes are correct, paste the sealing strips on TEC tightly according to TEC back drawing to ensure no gap or leaking between TEC and enclosure after installing and sealing.

*****注意*** CAUTION *****

注意：在贴密封条的时候要小心，该材料可能会因延展导致开孔被阻挡。如果机箱不密封或者空调在运行时机箱门打开着，空气中水分会进入系统里，可能会导致有冷凝水流出。

Be careful while pasting the sealing strips. The material may stretch caused mounting holes stucked. If the enclosure is not seal well or TEC operates with the enclosure door(s) open, moisture will access into the system and may cause the condensate water outflow.

d) 密封条贴好之后，将空调安装在设备机箱上并用**螺丝锁紧**。检查连接线（电源线、控制线、数据线等）是否在合适的位置。密封条应稍微压紧，空调与机柜间没有明显的缝隙。完成以上工作空调就可以开始工作了。

After pasting sealing strips, mount TEC onto the enclosure and fasten it using the supplied nuts and bolts. Check to see if connecting lines (power supply line, control line, data line) are in place. Tighten the sealing strips forcedly, there are no apparent gaps between TEC and enclosure. After completing the above, TEC is now ready to begin operation.

NOTE: Near the bottom or on the side of the Rimedyne system cabinet is a nipple for condensate overflow. Although all vertical or side mounted Rimedyne air conditioners have built-in condensate management systems, it may be necessary to attach a drain hose to this nipple on enclosures which are located in extremely humid conditions, or where enclosure doors are left open or the door seals are leaking.

注意：靠近空调机柜的底部或是侧面有一个冷凝水出口。虽然所有的顶置或侧置空调内部都设有冷凝水排出系统，但在十分潮湿的条件下，或是机箱门经常处于开放状态或是门的密封性不好，都需要在空调的出水口上接一个排水软管，防止冷凝水流入设备箱。

6.功能介绍 **Functionality Introduction**

6.1 电源供电 **Power Supply**

制冷空调需要直流供电，否则会有报警指示。其具有防反接功能。电源的纹波系数应小于 10%。

The unit should be feed by DC, otherwise it gives power failure alarming. With the anti-reverse feature, the DC power Vp-p should be less than 10%.

6.2 风机转速和加热，制冷功能，机柜内部温度曲线 **Fan Speed, Heating and Cooling functions, Cabinet inside temperature Curve**

1. 制冷模式 **Cooling mode**

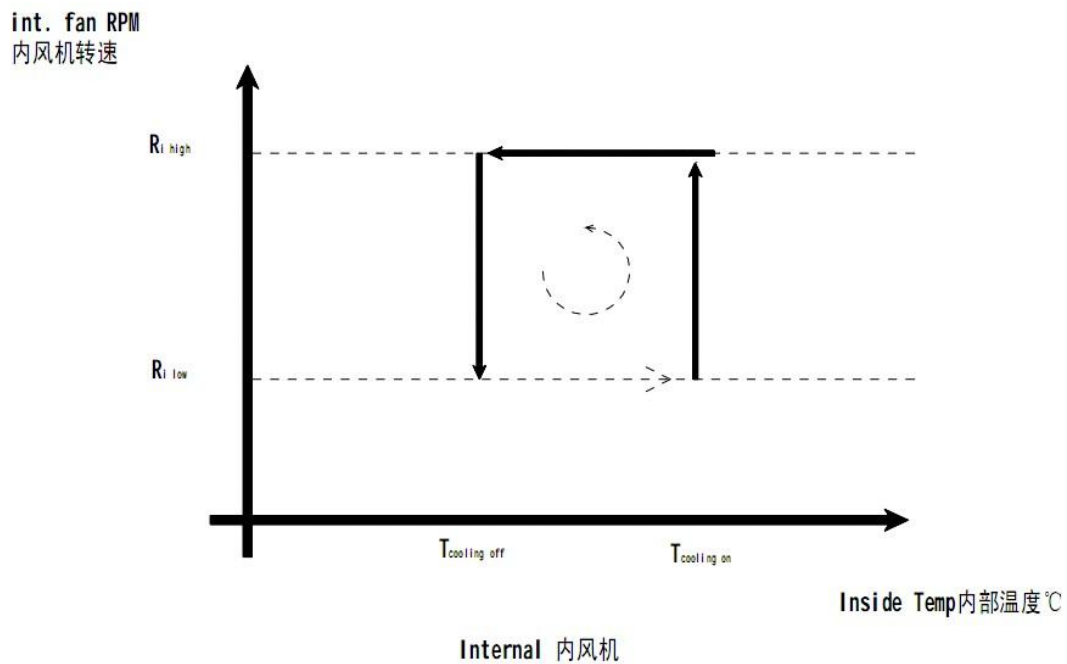

Ext. fan RPM
外风机转速

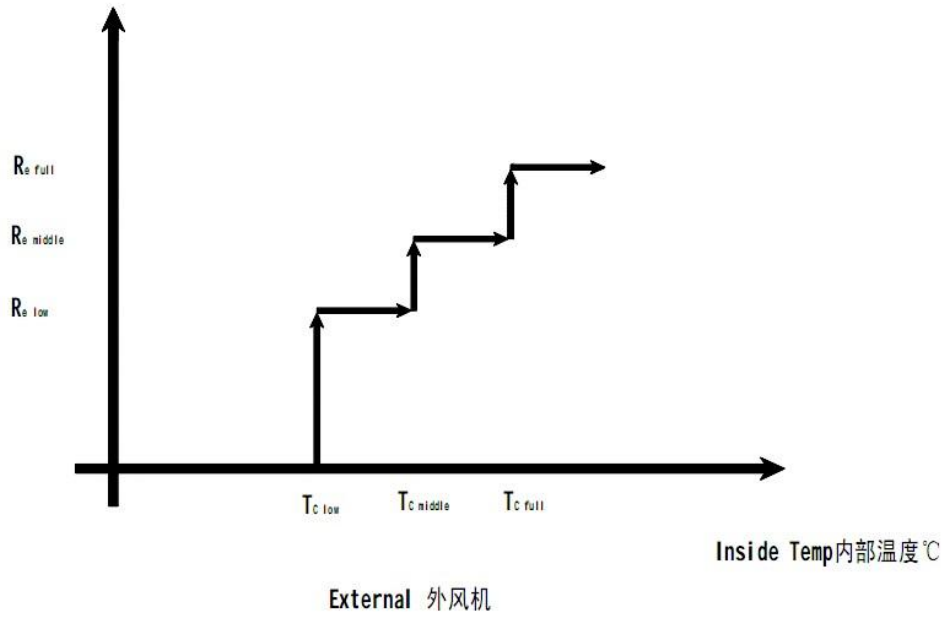

制冷模式控制参数的定义

Definition of cooling mode control parameters

$R_{i\ low}$	内风机低转速 Internal fan low Speed – RPM	60%
$R_{i\ high}$	内风机全速 Internal fan full Speed – RPM	100%
$T_{cooling\ off}$	制冷停止温度 Temperature for cooling stop working	24°C
$T_{cooling\ on}$	制冷开始温度 Temperature for cooling working	30°C
$R_{e\ low}$	外风机低转速 External fan low Speed – RPM	70%
$R_{e\ middle}$	外风机中转速 External fan middle Speed – RPM	80%
$R_{e\ full}$	外风机全速 External fan full Speed – RPM	100%
$T_{c\ low}$	制冷低速温度 Temperature for cooling low speed working	30°C
$T_{c\ middle}$	制冷中速温度 Temperature for cooling middle speed working	35°C
$T_{c\ full}$	制冷全速温度 Temperature for cooling full speed working	40°C

2. 制热模式（可选） Heating mode (optional)

int. fan RPM
内风机转速

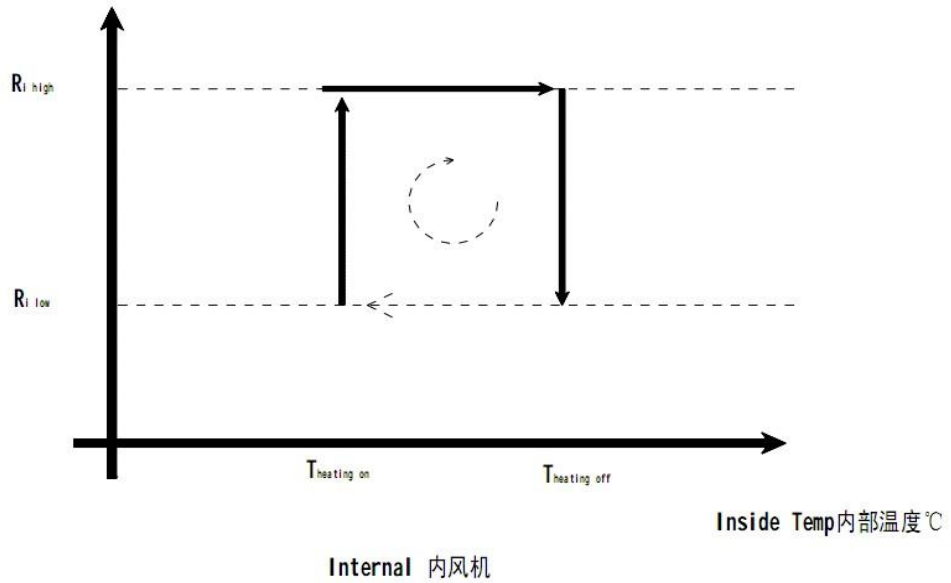

Ext. fan RPM
外风机转速

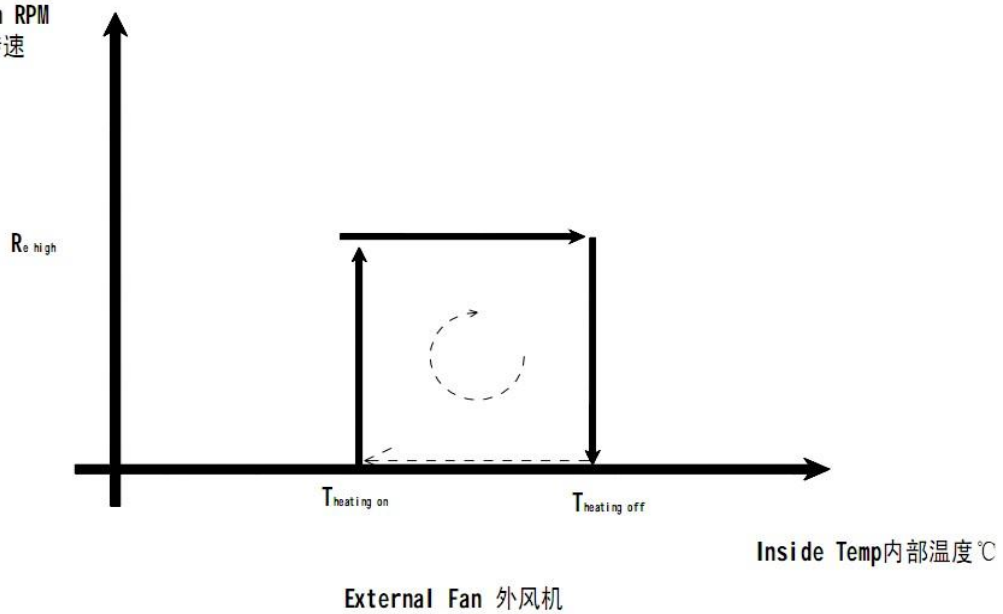

制热模式控制参数的定义

Definition of hoting mode control parameters

$R_{i \text{ low}}$	内风机低转速 Internal fan low Speed – RPM	60%
$R_{i \text{ high}}$	内风机全速 Internal fan full Speed – RPM	100%
$T_{\text{heating off}}$	加热停止温度 Temperature for heating stop working	15°C
$T_{\text{heating on}}$	加热开始温度 Temperature for heating start working	5°C

6.3 指示灯 Lighting

在控制板上有 2 种颜色的指示灯，请参照以下定义。

There are two led on control board, please refer to below definition

指示灯 LED	标签 Label	颜色 Color	状态 Status		定义 Definition
电源指示灯 Power Indicating Light	运行 Run	绿色 Green	On		正常运行 Normal running
			3Hz lighting		自检 Self-checking
			Off		无电源供给或故障 No power supply or faults
LED 报警指示灯 Alarming Indicating Light	警报 Alarm	红色 Red	开 On	闪烁次数 Lighting times	报警定义 Alarm Definition
				1 times	机柜内温度传感器故障 Cabinet inside temperature sensor defected
				2 times	柜外温度传感器故障 Cabinet outside temperature sensor defected
				3 times	柜内低温报警 Cabinet inside low temperature alarming
				4 times	柜内高温报警 Cabinet inside high temperature alarming
				5 times	柜内低温报警 Cabinet outside low temperature alarming
				6 times	柜内高温报警 Cabinet outside high temperature alarming
				7 times	内风机故障 Inner fan defected
				8 times	外风机故障 External fan defected
				9times	TE 过流报警 Over current alarming
				10 times	TE 欠流报警 Low current alarming
				11 times	系统供电电压过高报警 Over voltage supply alarming
12times	系统供电电压过低报警 Low voltage supply alarming				

备注:

在上述表格中描述的报警指示灯闪烁次数定义为：以 3Hz 的频次，在 2S 的时间间隔后连续闪烁的次数！

Note:

The definition of the lighting times of alarming indicating light showed in the above table is based on 3Hz frequency, continuous flashes in 2s interval time.

6.4 故障分析 **Fault Analysis**

故障现象 Faults	故障问题点 Fault issues	建议/解决方案 Suggestion/Solution
1. 连接电源后空调没有任何动作 TEC cannot work after power supply	1. 电源电压过低/过高, 电源线断开 Power supply low/over 2. 正负极接反 Connect reverse positive and negative pole 3. 控制板损坏 Controller panel damage	1. 检查电源, 测量输入接口电压 Check power supply 2. 重新接线 Rewiring 3. 更换控制板 Replace controller panel
2. 空调开启后有异常噪音/风机不启动 Abnormal noise/fan cannot work after TEC starting	1. 外壳有轻微变形挤压风机扇叶造成阻碍 Crush fan fins because of shell slightly deformation caused hinder 2. 风机网罩受到挤压变形, 造成阻碍 Fan guard crushed into deformation, cause hinder 3. 风机损坏 Fan damage	1. 修理/更换外壳 Repair/replaceshell 2. 修理/更换风机网罩 Repair/replace fan guard 3. 更换风机 Replace fan
3. 空调通电后不制冷(电流在 2A 以内), 控制板上绿灯亮, 红灯灭 Cannot cool after power supply (electric current into 2A), green light is on while red light is off on the controller panel	1. 冷端温度低于制冷启动温度 Cooling temperature is lower than cooling starting temperature 2. 冷端温度高于制冷启动温度 Cooling temperature is higher than cooling starting temperature	1. 正常情况 Normal situation 2. 满足制冷条件后 TE 会在 3min 内启动 After TE refrigeration condition will start within 3 min
4. 空调通电后不制冷(电流在 2A 以内), 控制板上绿灯亮, 红闪烁 Cannot cool after power supply (electric current into 2A), green light is on while red light is flashing on the controller panel	1. 闪烁次数 1 次 机柜内温度传感器故障 Flash one time Cabinet inner Temp.sensor fault 2. 闪烁次数 7 次 内风机故障 Flash four times Inner fan fault 3. 闪烁次数 8 次 外风机故障 Flash five times External fan fault 4. 闪烁次数 9 次	1. 检查传感探头是否有损坏或插头松动, 并进行替换或重新连接插头 Check sensor damaged or plug loose or not, replace or re-connect plug 2. 检查内风机线是否有损坏或插头松动, 并进行替换或重新连接插头 Check inner fan lines damaged or plug loose or not, replace or re-connect plug 3. 检查外风机线是否有损坏

	<p>TE 过流报警 Flash eight times Over current alarming</p> <p>5. 闪烁次数 9 次 TE 欠流报警 Flash nine times Low current alarming</p> <p>6. 闪烁次数 11 次 系统供电电压过高报警 Flash eight times Over voltage supply alarm</p> <p>7. 闪烁次数 12 次 系统供电电压过低报警 Flash nine times Low voltage supply alarm</p>	<p>或插头松动，并进行替换或重新连接插头 Check external fan lines damaged or plug loose or not, replace or re-connect plug</p> <p>4. TE 运行电流超过设定值，请重新设置“TE 过流报警”数值，并重新启动设备。 TE running current more than set value, please reset "TE over-current alarm" values, and restart the device</p> <p>5. TE 运行电流小于设定值，请检查 TE 连接线是否损坏/连接点螺丝松动，并进行更换连接线/锁紧螺丝 TE running current is less than the set value, please check TE problem is damaged/connection screw loosening, and replace the cable/lock screw</p> <p>6. 在运行过程中电压超出范围，请检查电源电压 Exceed voltage range while operating, please check power voltage.</p> <p>7. 在运行过程中电压超出范围，请检查电源电压 Exceed voltage range while operating, please check power voltage.</p>
--	---	---

6.5 电压保护 Voltage protect

输入电压小于-54V 且大于或者小于-44V 时，系统将不启动，但是电压恢复到-54v 到-44 之间时，系统恢复正常（不自检）

When the system voltage is less than -54V and more than -44V, the unit will stop work. But if the voltage recovers to between -54V and -45V, the unit will work again (no self-checking).

6.6 误报警过滤功能 **False alarm filtering function**

检测到故障持续 10 秒钟才判定为故障，红色报警指示灯亮，同时输出故障总报警。

The red alarm LED will be lighting after fault happening in 10S, meanwhile the general fault alarm will active.

- **无极性干节点继电器功能**

Relay of no polarity dry switch function

功能 1: NC 型报警 (可选)

报警方式: 正常闭合, 无极性干接点输出

Function 1: NC type Alarm, (option)

Alarming type: normally close, no polarity dry contact output

如果任何一个零件故障, 如内风机报警、TE 模块、机柜内温度、温度传感器都会产生系统报警。次报警方式仅用于总报警, 报警时不能明确具体的失效零件类别。

Unit alarm will be activated when any component happens failure, for example, the internal and external fan alarming, the TE module, and the cabinet inside temperature as well as temperature sensor. The second alarm is only for general alarm, it cannot indicate which component is failure.

序号 NO	报警定义 Alarm definition	反馈 Feedback	备注 Notes
1	内风机故障 Internal fan failure	报警输出, TE 模块停止工作 Output alarming and TE module stop work	NC Type
2	外风机故障 External fan failure	报警输出, TE 模块停止工作 Output alarming and TE module stop work	NC Type
3	TE 模块故障 TE module failure	报警输出, TE 模块停止工作 Output alarming and TE module stop work	NC Type
4	高低温度 40°C 和 0°C High and low temperature 40°C and 0°C	报警输出 Output alarming	NC Type
5	温度感应器故障 Temperature sensor failure	当系统电压在-45V 和-54V 时, 报警输出。内外风机, TE 模块继续保持停止工作状态 (制冷或是加热)。 Output alarming if the unit voltage -45V and -54V. Internal and External fans, TE module keep working as the status previous (cooling or heating) all the time	NC Type

功能: 继电器可以带负载, 单素在须同时满足下列条件:

最大电压: 277VAC/30VDC

最大功率: 1385VA/150W

最大负载电流: 5A

Function 2: The relay can be feed with load(S), but the load should meet the following requests:

Max.voltage:277VAC/30VDC

Max.power:1385VA /150W

Max.load current: 5A

6.7 后台监控协议 **Monitor protocol**

协议兼容性 **Protocol Compatibility**

该半导体制冷空调器控制板，支持 MODBUS 网络控制，所有的信息传送遵循公共 MODBUS 协议标准。该半导体空调制冷器，所支持消息帧传输模式：RTU 模式，8 为数据位，无效验位，1 位停止位，CRC 校验，波特率 9.6Kbit。信息回答等待最长时间 50ms

The TEC control panel, support all MODBUS network control, information transmitting following MODBUS protocol standards. The TEC refrigerator support all information frames transmission modes the agreement specifically agreed .please inquires MODBUS.ORG webs (<http://www.modbus.org>)

The semiconductor refrigeration air conditioner ,the support frame transmission mode: RTU mode, 8 data bits, no parity, a stop bits, CRC checking , baud rate 9.6 Kbit. The longest time of information answer is 50ms.

6.8 控制板接口 **Control board interface**

接口 connector	描述 Description	规格 Dimension
J1	48V 直流电源 48V DC power supply	7.5mm*2pin
J2	连接电源 TE power supply	7.5mm*2pin
J3	舱内温度传感器 Cabinet inside temperature sensor	2.54mm*2pin
J4	内风机 Internal fan	3.96mm*4pin
J5	外风机 External fan	3.96mm*4pin
J6	干接点报警 Dray switch alarming connector	2.54mm*2pin
J7	RS485 端口 RS485 port	2.54mm*2pin
J8	排氢风机 Hydrogen exhaust fan	5.0mm*2pin

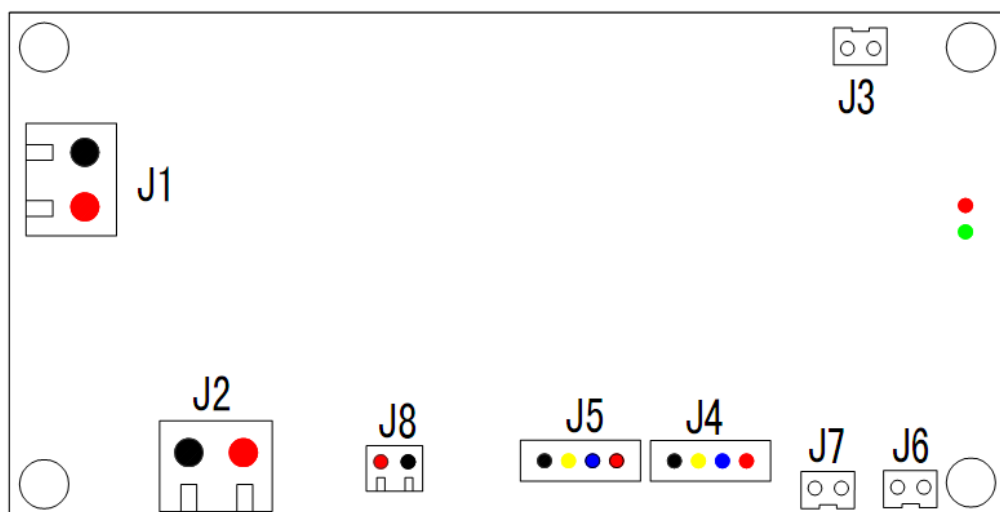



7.界面说明 Interface Introduction

7.1 PC 监控软件操作

PC monitoring software operation

a) 监控软件的启动

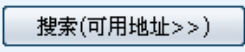
Monitoring software start

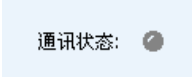
打开软件后点击  ，软件会搜索已连接的设备，点击后  绿色状态灯开始闪烁，（如果状态灯没有闪烁，请检查线路连接是否正确、无松动），软件第一次搜索默认地址是“1”，如果有多个设备则按照搜索的顺序自动编号，搜索完毕后在右边的下拉下单中会出现已搜索到的设备地址，请选

择其中一个，点击  小方框开始定时召唤就可以显示当前设备的数据了，并可点击上翻/下翻自由设置定时召唤时间间隔（间隔时间范围 2000-999999 毫秒），

Open the software and then click the "search available address," the software will search the connected devices, and click on the "communication" green lights start flashing, (if there are no flashing status lights, please check the wiring is correct, no loose), software for the first time, search the default address is "1", if there are multiple devices in the search order numbering automatically, after the search on the right will appear in the drop-down order had been searched device address, please select one of them, click on "T timing call" small square start timing calls can display the current equipment data, and can click on turn down/free set call timer interval time interval (range 2000-2000 milliseconds),

如果空调与上位机已连接，通讯地址设置正确，且空调已通电，空调的状态与设置参数会正确读出并显示在相应的区域，通讯状态绿灯闪烁。如下图：

If air conditioner connected with computer, the setting of communication address is correct, and air conditioner being charging, the status and setting parameter will read and show in the related areas correctly, the LED of communication is green, as the below shows:



b) 报警与状态显示

Alarm and status display

串口号 通讯状态: ● 的设置应该与 RS232-RS485 转换器插入的串口号对应，如果电脑主机无串口，可使用 USB 转 RS232 串口。

监控软件有数据交换时指示灯会闪烁，同时会刷新数据。

The setting of Serial port should be corresponding with the insert serial port of RS232-RS485 converter. If there is no serial port in the computer, use USB convert RS232 serial port.

If there any data exchanging of monitoring software, indicating LED will flash, meanwhile refresh data.

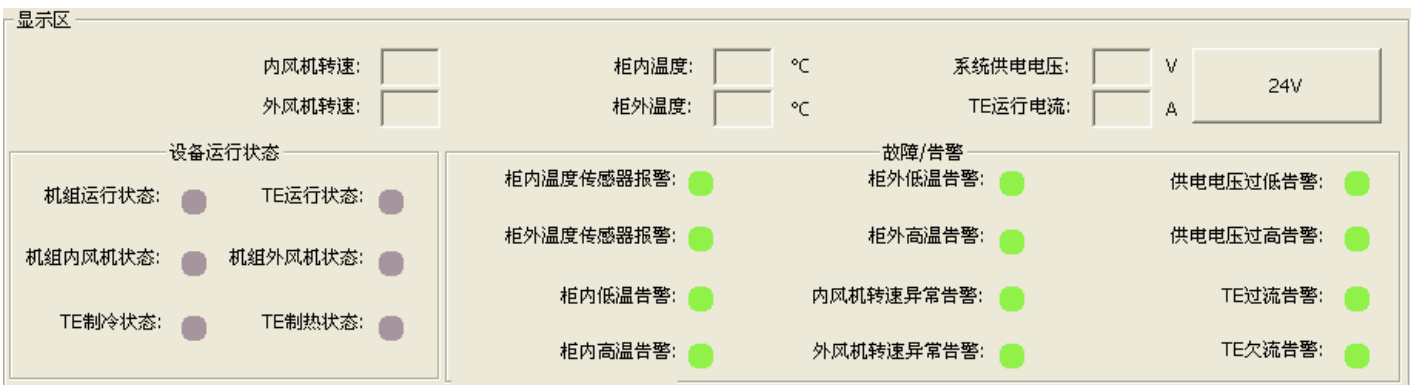

显示区：上面部分显示设备当前运行时的参数（风机转速、内外环境温度、电压电流），不可更改
最右边是 24V/48V 转换按钮, 用于监控 24/48V 设备（如果软件电压和设备电压不一致则此软件现实的所有数据都不能做为参考）。

设备运行状态：显示当前设备各个原件的运行状态，绿色表示正在运行状态，灰色表示停止状态。

故障/告警：设备原件是否正常运行/设备运行环境是否正常，绿色表示正常，红色表示报警
设备报警排除见 6.4 故障分析。

Display area: the part of a display device of the current runtime parameters (inside and outside fan rotational speed and environmental temperature, voltage, current), cannot be changed, Most the right side is 24 v / 48 v switch button, used to monitor the 24/48 v device voltage (if the software is the software and equipment voltage is inconsistent when the reality all the data as a reference).

Equipment running status: show the current status of each of the original equipment running state, green said gray said stop state.

Fault/warning: original equipment/device running environment is normal whether normal operation, the green is normal, the red alarm, See 6.4 fault analysis equipment alarm ruled out.

c) 空调设置区

Air conditioner setting area

参数设置可根据空白处后面的下拉菜单选择数值并点击选择

1. 内外风机转速参数：在此处可设置风机的最低/最高转速，系统会根据环境温度在转速范围内自动调节该风机的转速。（设置最高转速不能超过风机最高转速）
2. 温度设置区：

TE 制冷启动温度：当内环境温度超出此设置温度时开始制冷

TE 制冷回差温度：当内环境温度小于 TE 制冷温度-TE 制冷回差温度时制冷停止

TE 制热启动温度：当内环境温度小于此设置温度时开始制热

TE 制热回差温度：当内环境温度大于 TE 制热温度+TE 制冷回差温度时制热停止

柜内低温告警温度：当内环境温度小于此设置温度时  呈红色报警状态

柜内高温告警温度：当内环境温度大于此设置温度时  呈红色报警状态

柜外低温告警温度：当外环境温度小于此设置温度时  呈红色报警状态

柜外高温告警温度：当外环境温度大于此设置温度时  呈红色报警状态

3. 修正设置：

温度探头修正：用来修正 PC 显示温度与实际温度的误差。

系统电压修正：用来修正 PC 显示电压与实际电压的误差。

4. 电流电压设置：

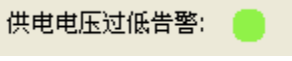
低电压告警电压值：当显示电压低于此设置电压时  呈红色报警状态

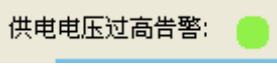
高电压告警电压值：当显示电压高于此设置电压时  呈红色报警状态

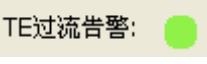
TE 工作电流上限：当显示电流高于此设置电流时  呈红色报警状态

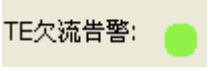
TE 工作电流下限：当显示电流低于此设置电流时  呈红色报警状态

5. 排氢风机时间设置：间隔：排氢风机每 2 次工作之间的间隔时间（单位：小时）

工作：排氢风机每次工作时间（单位：min）

6. 通讯地址设置：可正设定当前设备的编号（范围 1-255），当前设备地址可在通讯设置区



Parameters set up according to space at the back of the drop-down menu to select value and click select

Fan speed parameters:

6. The inside and outside the fan low/high speed can be set up here, the system will automatically in the speed range according to the environmental temperature to adjust the fan speed. (set the highest speed should not exceed the highest fan speed)

7. Temperature Settings area: TE refrigeration start-up temperature: when the ambient temperature exceeds the set start cooling temperature

TE refrigeration return difference temperature: when the environment temperature is less than TE refrigeration temperature - TE return difference temperature refrigeration is stopped

TE heating start-up temperature: when the environment temperature is less than the set temperature in start heating

TE heating return difference temperature: when the ambient temperature is greater than TE TE refrigeration and heating temperature + return difference temperature heating stops

Inside low temperature alarm: When the inside environment temperature is less than the "internal low temperature alarm" red alarm

Inside High temperature alarm: When the inside environment temperature is more than the "internal High temperature alarm" red alarm

Outside low temperature alarm: When the Outside environment temperature is less than the "internal low temperature alarm" red alarm

Outside High temperature alarm: When the Outside environment temperature is more than the "internal High temperature alarm" red alarm

8. The correct Settings:

temperature probe correction: To revise the PC shows that the error of the temperature and actual temperature

System voltage correction: To revise the PC shows that the error of the voltage and the actual voltage.

9. Current and voltage Settings:

- Low voltage alarm voltage values: When the voltage is less than the "internal low Voltage alarm" red alarm
- High voltage alarm voltage values: When the voltage is more than the "internal high Voltage alarm" red alarm
- TE maximum working current: When the TE working current is more than the "internal high TE working current alarm" red alarm
- TE minimum working current: When the voltage is less than the "internal low TE working current alarm" red alarm
- Set time hydrogen exhaust fan:
Interval: hydrogen exhaust fan, the time intervals between every two working (unit: h)
Work: hydrogen exhaust fan every work time (unit: min)
 - Address Settings: it can be set is the serial number of the current equipment (range 1-255),
The current device address in the communication setting area display "search available addresses"

7.2 电路板线路图 **Electrical Interface-Circuit diagram**

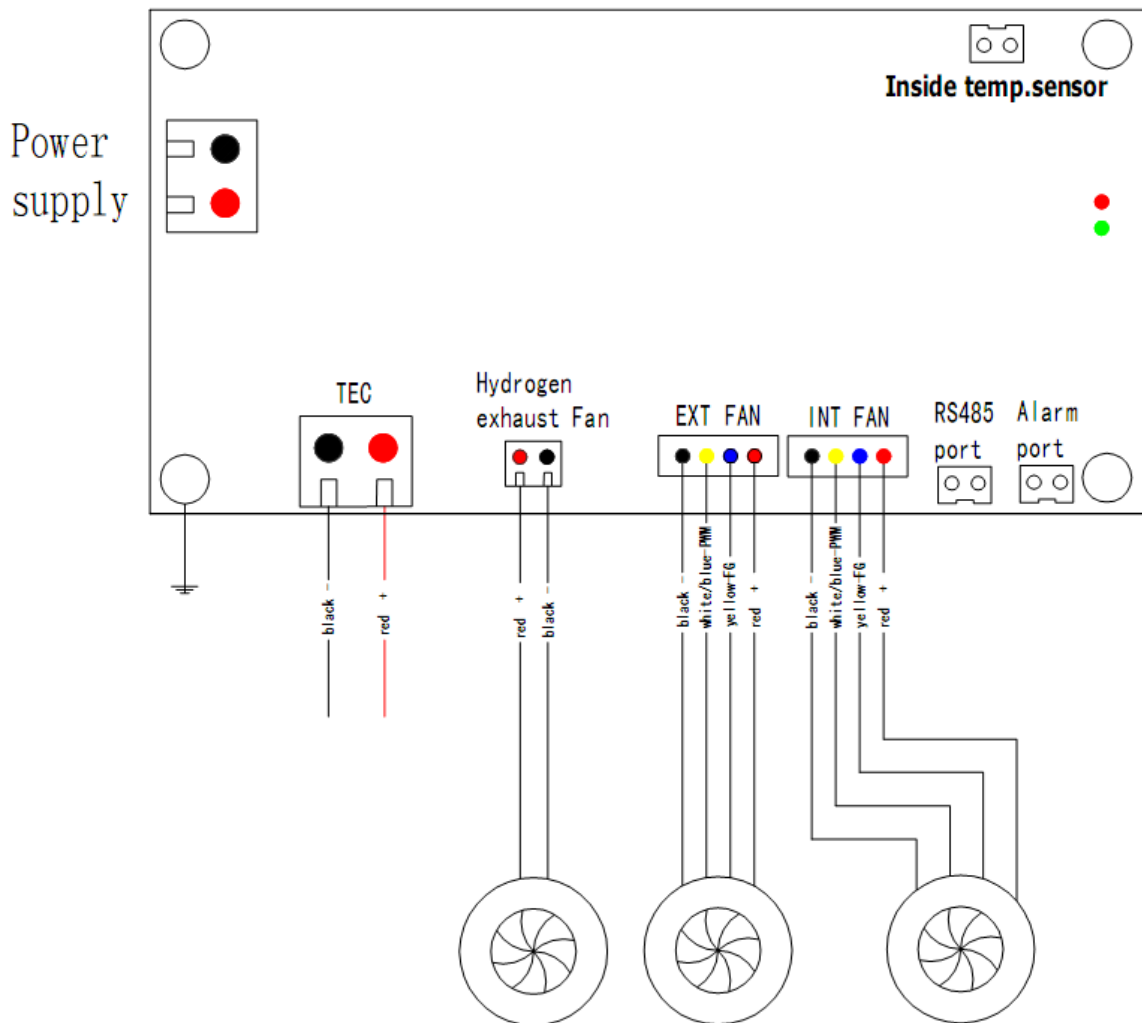

7.3 电源 Power Input

制冷空调需直流供电，建议在使用制冷空调之前安装以下规格的断路器。

DC fuse) = 22Amps

The unit must be charged by DC power, suggest install the below dimension circuit breaker before using TEC.

DC fuse) = 22Amps

7.4 安装注意事项 Installment cautions

- 不可安装在可能有易燃性气体泄漏的地方，若有泄漏的燃气在机组周围积聚，会导致火灾事故。
Should not install the place where may happen flammable gas leak easily. If enclosure surrounding leaking gas, it will cause fire accident.
- 不可安装在直对热源或明火的地方，否则可能引起发热或火灾。排气进口请勿放置在能够吸入高温、高湿空气的位置。
Should not install the place where opens to heat source or fire, otherwise it will cause fire accident. Exhaust inlet should not be placed in the location high temperature and moisture.
- 不可用湿手对机组进行操作，否则可能有触电危险。
Should not touch enclosure with wet hand, otherwise it will cause electric shock hazard.
- 电气安装注意事项
Electric mounting cautions
只有专业人员才允许电气连接和维护。
Only specialized person allow connecting and maintaining electric.
必须使用对应的电源，如果使用不同的电源电机可能会烧坏。
Must use right power supply, machine may be burnout if using different power supply.
接线结束后，在开电源之前要再次检查连接有无错误。
Finishing lines connecting, check twice to see any mistakes or not before switching on power supply.
电源接入设备前应安装保护器确保人身及设备安全。
Should install protector to ensure body and equipment safety before connecting equipment into power supply.

8. 保修 Warranty

齐力公司向用户保证，齐力生产的产品没有材料和工艺上的缺陷。如果用户在一年之内（保修期）发现产品有质量问题，可通知齐力公司，退回这个产品给齐力。用户可以选择维修该产品或是更换有同等价值的其它产品，但需支付货费用。不管是哪一种选择，维修或是更换产品后的保修期都会按新购产品重新算起。如果用户没有通知齐力公司这类缺陷，不管保修期内是否存在潜在的问题，齐力公司对用户没有进一步尽义务。因而在何种情况下，齐力对产品缺陷承担的责任上限不超过产品本身的价格，使用引起的间接损失本公司不承担连带责任。在任何情况下，对偶然因素或不可抗力因素造成的损失本公司不承担相关责任。上述

的赔偿方式也只是在此次交易中卖方违反了质量保证后给予客户的唯一赔偿。

Rimedyne guarantee users, Rimedyne products have no materials and technology defective. If users find any quality problems from a product in a year (under warranty), contact Rimedyne immediately, return it to Rimedyne. User can choose maintain this product or replace other products of the same value, but need to pay for freight. No matter which choice, warranty will be renew as new product after maintaining or replacing products. If users do not inform Rimedyne such defectiveness, even there are some problems under warranty, Rimedyne have no further duty on users. As for this situation, compensation for defective products will not exceed its price; Rimedyne will not undertake joint liability if caused indirect loss. In any case, Rimedyne will not be obligated to any loss caused by accidents or irresistible force. The above compensation method is the only compensation if seller defaults quality guarantee during this transaction.

8.1 免责声明 Disclaimer Range

- 已超过保修期限的。
Expire warranty period.
- 不能提供产品出厂编号的（见机身贴示的铭牌）。
Cannot provide product manufacturing number (refer to enclosure brand).
- 用户自行更换或拆装产品零部件造成损坏的，或由非授权服务拆修而造成损坏的。
User replace or detach products caused components damaged at will, or without authorization.
- 因用户电源电压不稳，超过空调器使用范围或线路不规范，不符合国家安全用电标准造成空调损坏的。
Use's power supply is not stable, exceeding air-condition usage range, wirings are unregulated, or not in accord with national security electric standard, as a result, damage air-condition.
- 由于运、装、用、管不当等导致空调物理损坏(如空调不能倒置)等。
Because of improper shipment, package, usage, management, cause Air-condition physical damage (such as cannot upside down).

9. 制造商地址 Manufacturer Address

齐力制冷系统（深圳）有限公司
中国广东省深圳市横岗镇安良五村福坑路172号
Longgang District Shenzhen 518115, Guangdong Province, China

网址: www.rimedyne.com.cn

电话: 0755-33821986

传真: 0755-33821988

Rimedyne Refrigeration System (Shenzhen) Co., Ltd
NO. 172, Fukeng Road, Anliang Village, Henggang Town,

Website: www.rimedyne.com.cn

Tel: 86 0755 3382 1986

Fax: 86 0755 3382 1988